

TSP-40

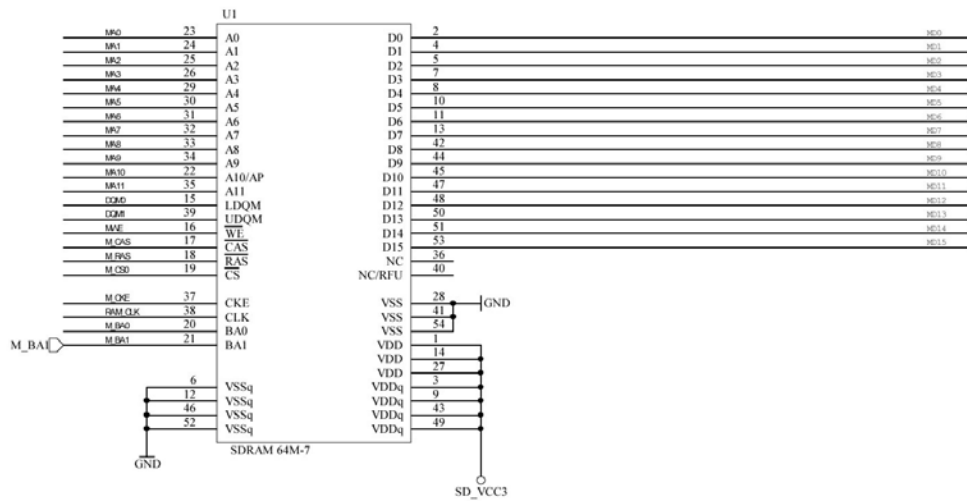

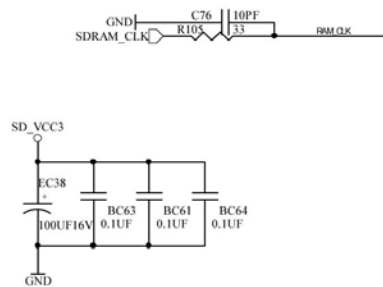

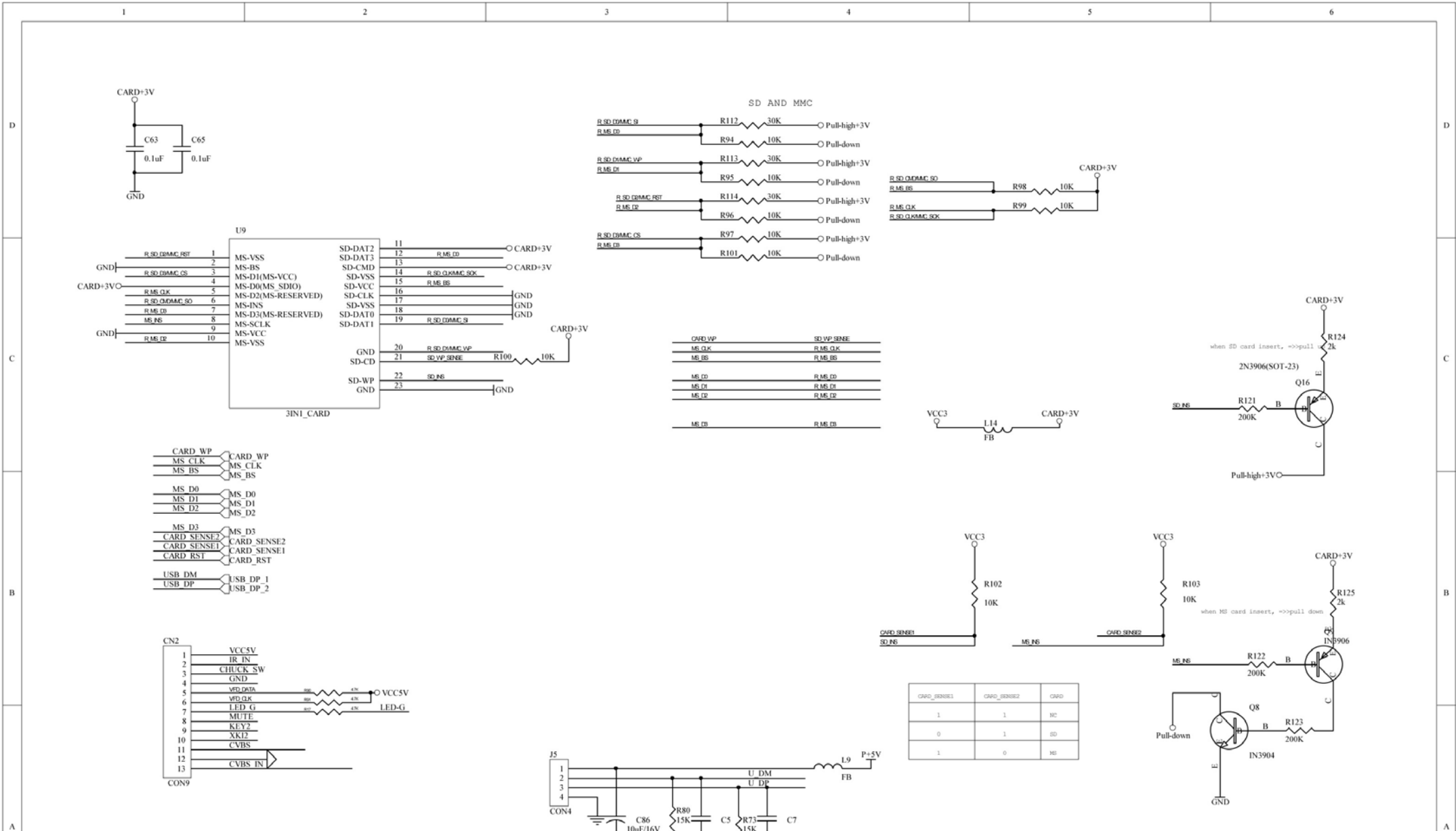

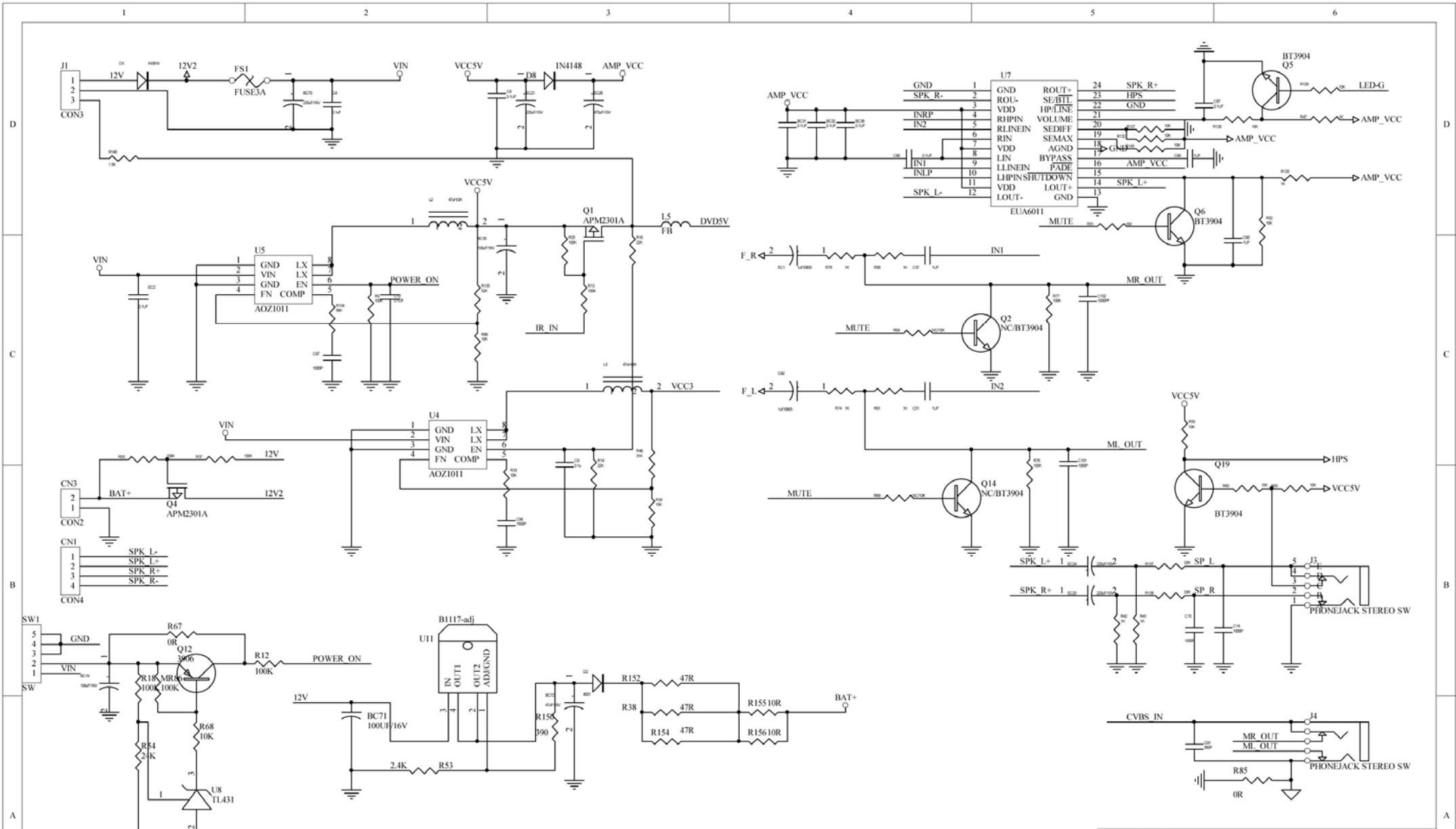
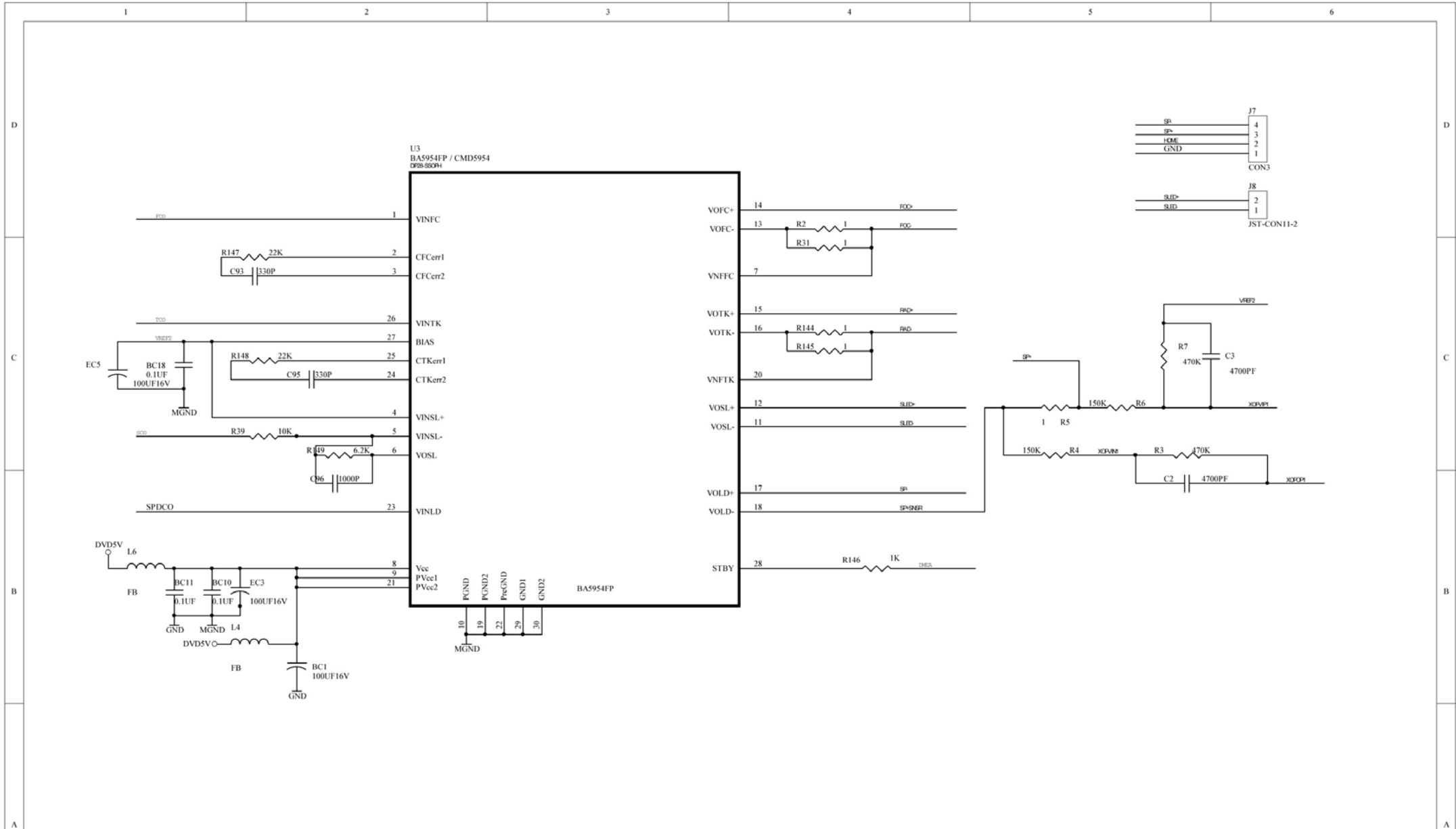

Power Bead > 2A, RAC@100 MHz = 70 ohm, RDC(max) = 0.4 ohm

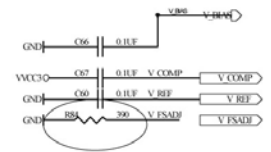
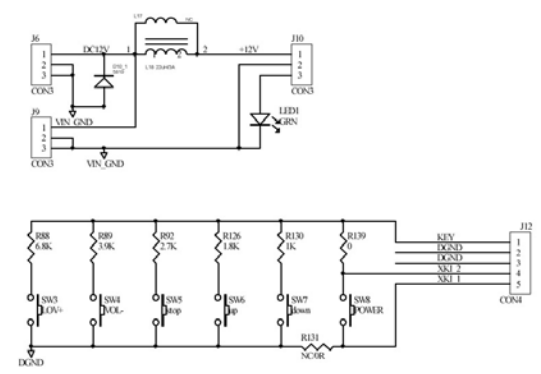
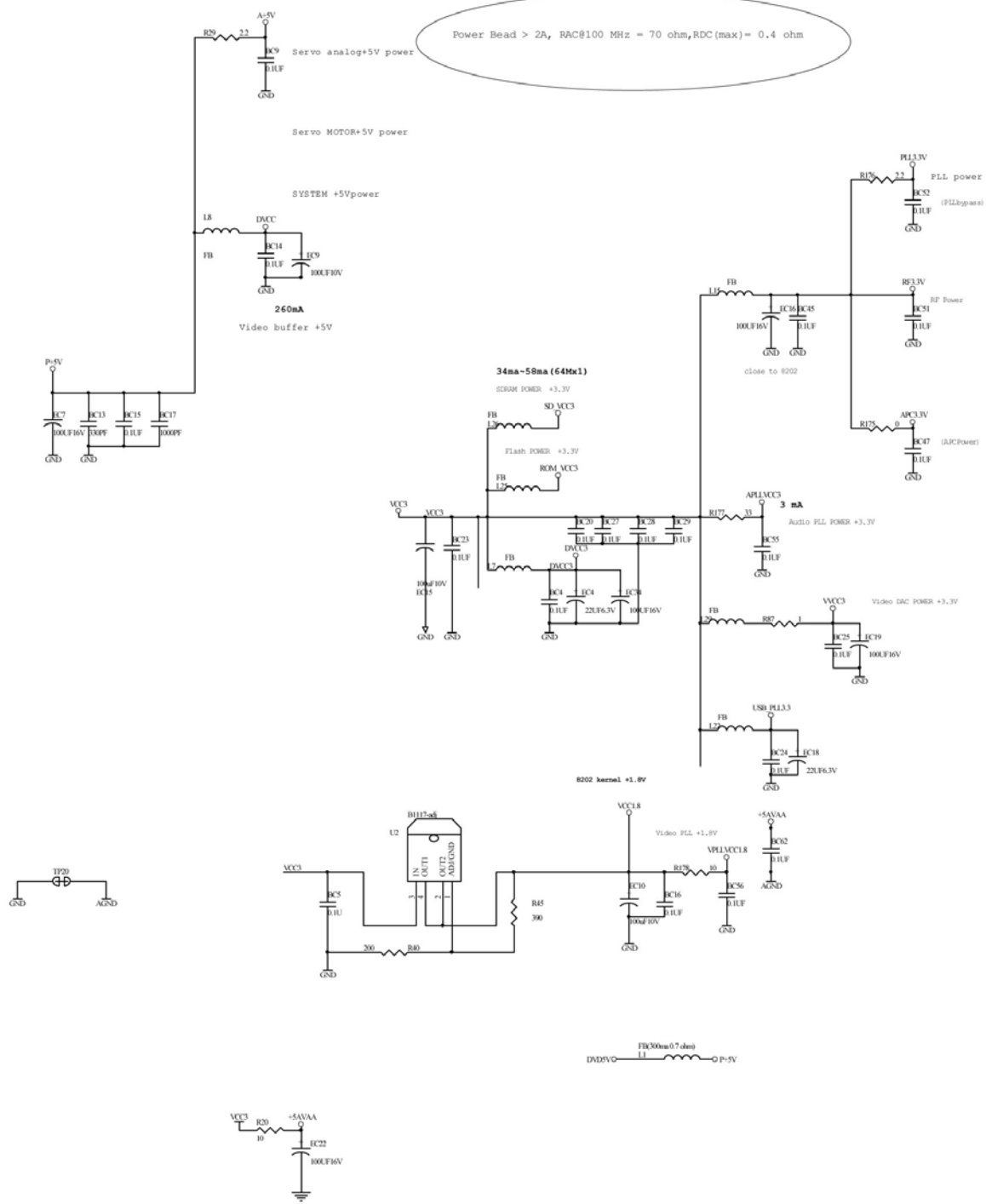

VVIDEO DAC	R118	R230	R251	R252	R61	
Full Current	390	0	0	0	75	
Half Current	690	NC	NC	NC	150	

